

Simple Troubleshooting Guide

Problem	Cause/Solution
No power	★ Check and make sure whether the fuse is blown, replace with the proper value if necessary.
Some errors occur in the LCD or no function when pressing the button.	★ Press the RESET button.
Unable to receive stations.	★ Check and make sure whether the antenna is inserted or the antenna is properly connected. if so, insert the antenna or connect it properly.
Poor effect on receiving a station.	<ul style="list-style-type: none"> ★ Antenna may not be the proper length. Make sure the antenna is fully extended or broken: if broken. Replace the antenna with a new one. ★ The broadcasting signal is too weak. ★ The antenna is poorly grounded, check and make sure the antenna is properly grounded at its mounting location.
ACD s cannot be loaded.	★ A C D s is loaded in the mechanism.
The stereo indicator “  ” is flashing.	<ul style="list-style-type: none"> ★ Tune in the frequency accurately. ★ The broadcasting signal is too weak.
No picture.	★ The Video line from main unit to the TV is not connected properly.
The picture noise appears.	<ul style="list-style-type: none"> ★ Improper setting of the color system. Set the color system to " PAL" or " NTSC". according to the connected television. ★ The CDs is dirty or damaged..

★ Note: If any of the problem persist after check list had been made, consult your nearest service dealer. Never attempt to disassemble your unit by yourself.

Owners Manual

CAR DVD /MP4/VCD/MP3/CD/ AM/FM STEREO SYS MULTI MEDIA PLAYER

Welcome!

Thank you for purchasing our company digital media player!
To operate the unit correctly, please read the owner's manual carefully before using the unit. Keep these instructions and retain this booklet for future reference.

Mounting Example ②

DETACHING THE FRONT PANEL

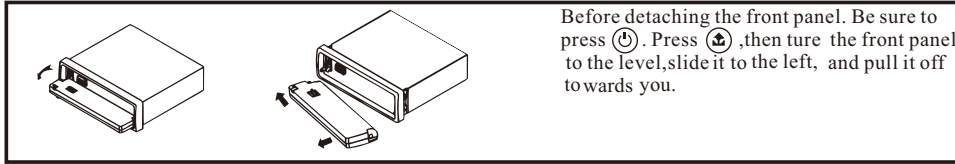

REPLACING THE FRONT PANEL

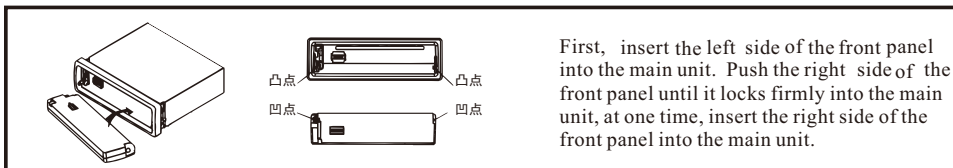

PRECAUTIONS

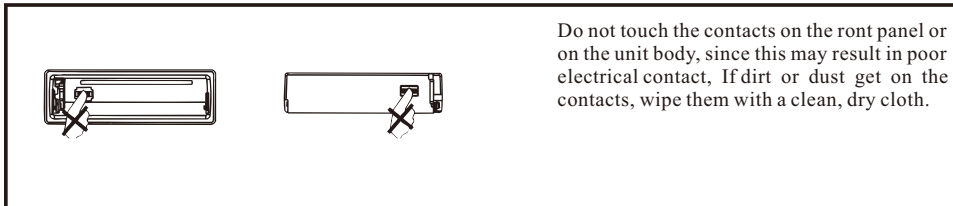



Notes on installation

- ☞ The unit is designed for **12V DC**, negative ground operation system only. Before installing the unit, make sure your vehicle is connected to **DC 12V** negative ground electrical system.
 - ☞ The negative battery terminal must be disconnected before making connections, which can reduce damaging the unit due to short circuit.
 - ☞ Be sure to connect the color coded leads correctly according to the diagram. Incorrect connections may cause the unit malfunction or damage the vehicle's electrical system.
 - ☞ Be sure to connect the speaker (-) leads to the speaker (-) terminal. Never connect the left and right channel speaker cables each other or to the vehicle body.
 - ☞ Do not block vents or radiator panels. Blocking them will cause heat to build up inside and may result in fire.
- ☞ After the completion of the installation and begin to play the unit (including replacing the battery), please press the **RESET** button on the front panel with pointed objects (such as ball-point pen) to set the unit to initial status.

Precautions

☞ This unit can play the following discs only.

Type of disc	Label on the disc	Recorded material	Size of disc
DVD		Sound and moving Pictures	12cm
VCD		Sound and moving Pictures	12cm
MP3/MP4	MP3/MP4	Sound and moving Pictures	12cm
CD		Sound only	12cm

Note: ① The unit is compatible with DVD.VCD1.0/2.0/3.0 DVCD.CD-RW. CD-R.PICTURE-CD version Disc.
 ② The manual conforms to DVD、VCD、MP3 and CD、If no DVD、VCD or MP3 on some models,you should ignore them. While enjoying DVD、VCD、MP3 and CD. the display will automatically identify the discs and indicate the corresponding words.

☞ Do not attempt to modify the unit, modifying the unit may cause an accident.

☞ Stop the vehicle before carrying out any operation that could interfere with your driving .

☞ Do not work in extreme high or low temperature inside the vehicle is between +55°C and -20°C before turning your unit on .

☞ To enjoy optimum sound and images while playing , handle the discs as follows :

— Handle the disc by its edge to keep the disc clean, and do not touch the surface.

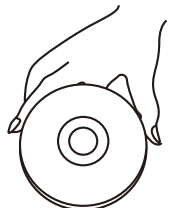

4

— Do not use your CDs with paste residue or ink attached .



— Do not use CDs with labels or stickers attached , which may leave a sticky residue while beginning to peel off. (Shown as picture)



— Clean the discs with an optional cleaning cloth .Wipe each disc from the center out. (Shown as picture)

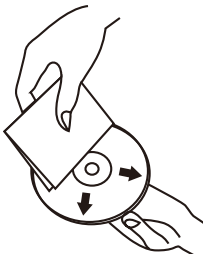

Installation

Parts List (The number in the list are keyed to those in the instructions)

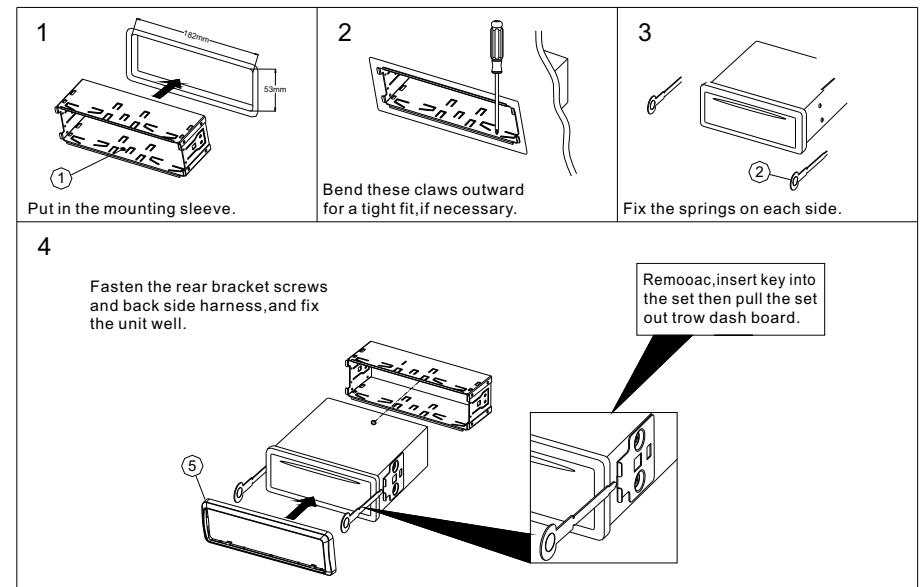
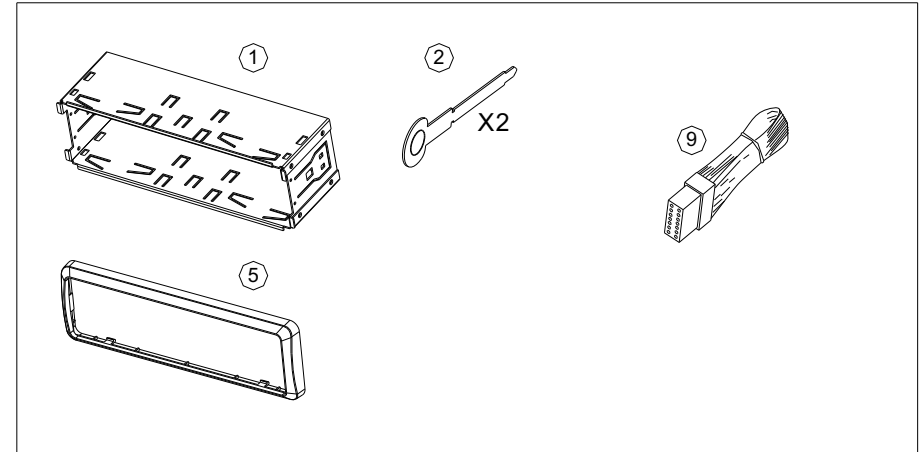

19

Location of the control

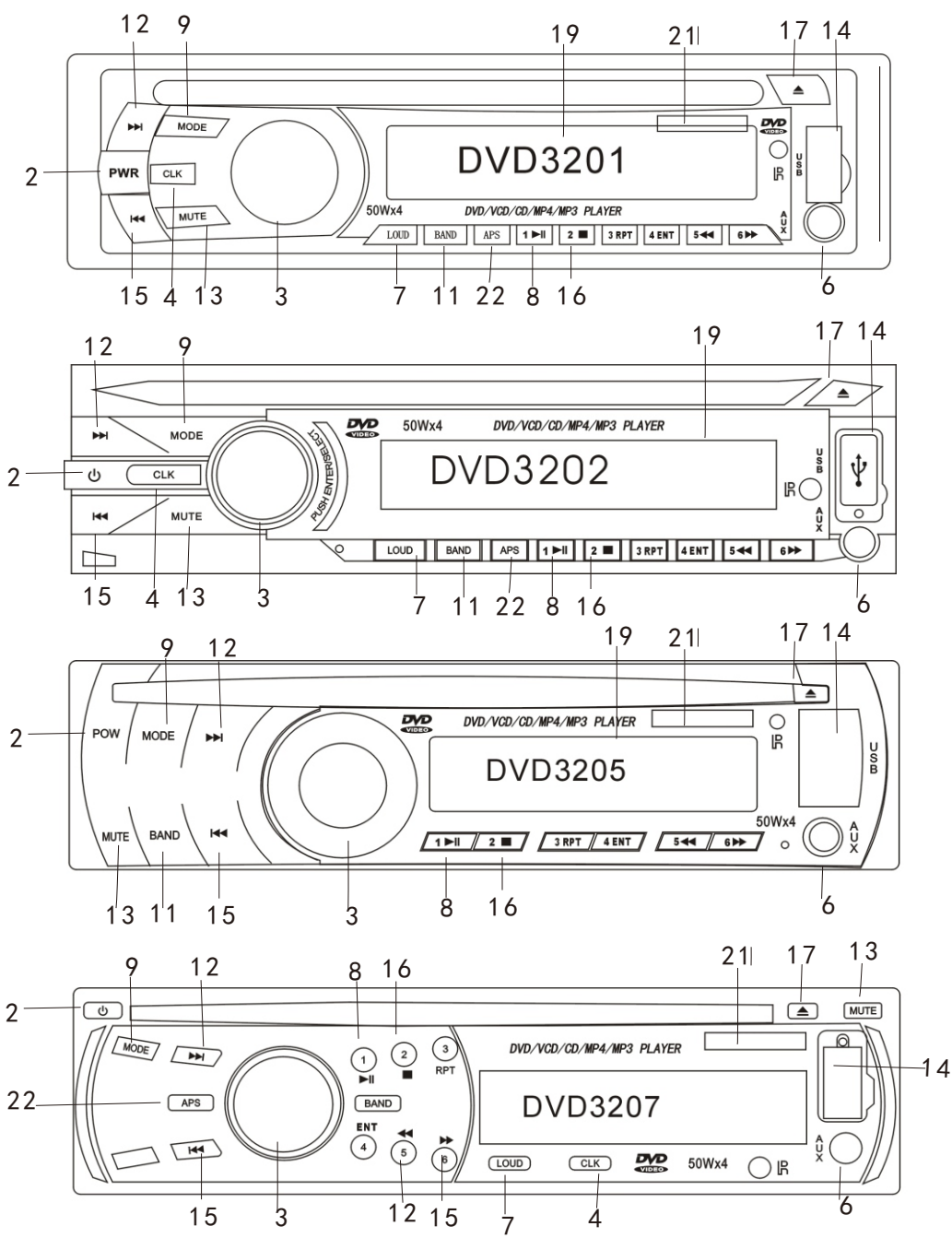

Remote Control Operation

- *****
- ★ **11. Selecting direction**
UP/DOWN/LEFT/RIGHT
 (↶ / ↷ / ↵ / ↴)
 - ★ **12. ENTER**
 The **UP/DOWN/LEFT/RIGHT** and **ENTER** are driver selection you want to playback
 - ★ **13. MENU/APS**
When you insert a DVD disc into the DVD player and start to play it:
 The unit will automatically start the playback from the beginning of the disc, and then the MENU will be brought up.
 Press **M Sn-O Bm l - l Ucd-H P g f r** to move the highlight in the MENU.
 Press **Enter** on the selected option
 When vcd mode control PCB ON/OFF
 Radio AS/PS(auto seek search tuning)
 - ★ **14. Pause/Play Button**
 Press **14 (▶||)** button to suspend the playback Of CD、MP3、VCD.
 DVD,USB,SD Press it again to return to normal playback mode.
 - ★ **15. STOP ■**
 Stop the current disc playback.
 Press **STOP** to enter the resume stop mode.
 Press **PLAY** under the resume stop mode to resume the playback from the location where you stopped the playback previously. Press **STOP** two times consecutively to enter the clear stop mode. Under the clear stop mode, if **PLAY** is pressed, the disc will resume the playback from the beginning of the disc
 - ★ **16. OSD**
16 OSD On/Off
 - ★ **17.**
 - ★ **18. LOUD**
18 Loud on/off,
 - ★ **19. EQ**
19 EQ to flat , class, pop, rock disp off
 - ★ **20. TRACK**
 Press **(◀ TRACK ▶)** button, you can select your desired portion downward or upward respectively
20 Radio SEEK /Track up/down
- *****

Remote Control Operation



C) You will first see the picture as shown on the left side after you enter the AUDIO setup menu page.



D) You will first see the picture as shown on the left side after you enter the LOCK setup menu page. The page is used to set the PARENTAL control
Note: when locked password, But disremember it, must to select LOAD DEFAULT > SELECT enter.



E) You will first see the picture as shown on the left side after you enter the OTHER setting page. The page is used to set the control

Location of the Control

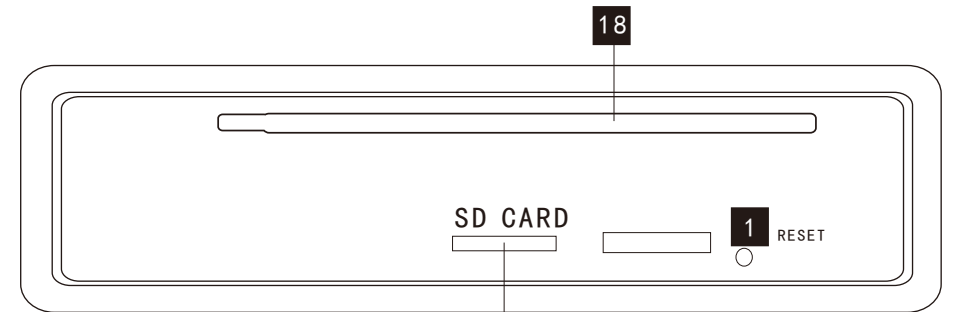
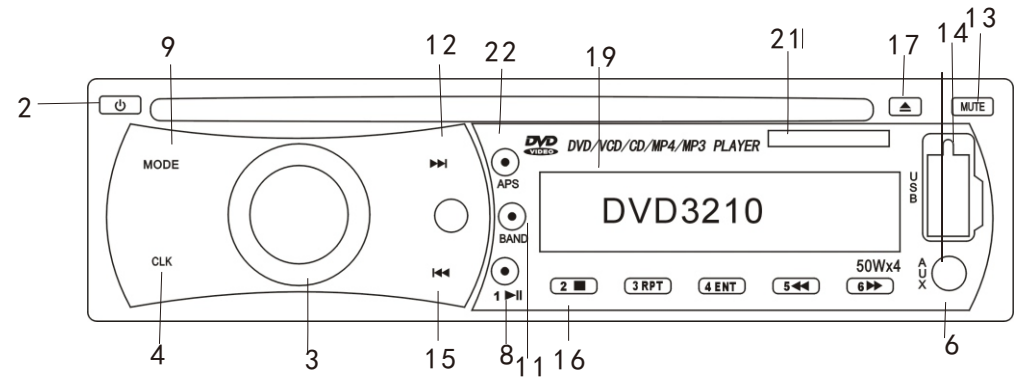

- 1 Reset Button
- 2 Power On/Off
- 3 Volume Control Press Setting the Sound Characteristics
- 4 Clock Button
- 5 ST(L/R) Audio pilot
- 6 AUX In
- 7 Loud On/Off
- 8 Disc play/pauss
- 9 Mode Button
- 10 Remote Control Receptor
- 11 Band Selector
- 12 SEEK UP (Tracks up)
- 13 MUTE On/off
- 14 USB In
- 15 SEEK down(Tracks down)
- 16 Number Buttons for radio /DISC/USB/SD
- 17 Eject Button
- 18 DISC Slot
- 19 LCD Display
- 20 Open(Release) Button
- 21 SD Card In
- 22 APS/BEARIN

Basic Operation

Display Screen Desc



DVD/VCD/MP3/CD for Tittl Chapter/Track
 DVD/VCD/MP3/CD for Time
 Radio/ Disc /Usb /Sd/aux

Initial System Start-up

1. Operating the unit for the first time or after replacing the car battery, you must reset the unit. Press **1** (RES) button with a pointed object (such as a ballpoint pen) to set the unit to initial procedure.

★ Note : When some errors occur in the LCD display , you can also press RESET button to resume to normal. And it will erase the clock setting and some memorized functions.

Turning the Unit On/Off

Power On/Off

2. Press **2** (PWR) button to turn on the unit, and press it again to turn off the unit.

★ Note : After the unit is off, if the volume level is higher than it is in initial setting , it will resume to initial status; if it is lower than that in initial status, it still store in the status which you set.

Vol/Bass/Tre/Bal(L-R)

/Fad(F-R)/LOUD/EQ Selector

3. For Volume Control **3**, rotate VOL knob clockwise to increase the sound level, and rotate it anticlock wise to decrease the sound level.

Repeatedly press **3** (SEL) button to select the desired mode in the following order:



(*OPTION*)

★ Repeat Playing

.During DVD mode , firstly Press (RPT) to repeat the current track being played; Press it again to repeat playing all the tracks.The third press it to cancel the repeating functional.

Repeat Playing

4. **4** Clock Button

Clock on/off ,when on Press seek up is hour 0~23,Press seek down is Minutes 0~59; off clock exit;

Remote Control Operation

DVD(DVD/VCD/MP3/CD)KEY ONLY

★ 6. Nuber buttons

The nuber(0~9,10+) buttons During the playing mode ,you can select any track directly by using (6)nuber button (0~9,10+)for example, if you need the fifteenth track, you can first press button 10+ and then press button 5, the corresponding track15, will be played.

Note: vcd-PBC mode play ,number button is not functional

★ 7. On-Screen Display/GOTO

Press **7** button. The Vidio shows : (See the pictrue)

- A)TITLE:
- B)CHAPTER:
- C)TIME:

★ 8. TITLE KEY

-- In DVD、 playing mode, Press **8** (TITLE) key to show all tracks 'title on TV screen. Then press (0~10+)key or press (◀/▶/⏪/⏩) key to choose your desired track number and press (ENTER) key or (▶||) KeyTo start.

Note: 1. No title display in MP3、 CD mode

2. For choose a desired language to press title key.

★ 9. FAST FORWARD/REWIND

During the playing mode, press **9** (◀ or ▶) button to fast rewind or fast forward for you to reach your desired quickly.

★ 10.SYSTEM SETUP MENU



A) You will first see the LANGUAGE menu page when the setup menu is brought up , asillustrated on the left



B) You will first see the picture as shown on the left side after you enter the DISPLAY setup menu page.

Remote Control Operation

Replacing the Battery

★ When the range of the operation of the card remote control becomes short or no functions while operating. Replace the battery with a new button cell. Make sure the battery polarity before replace.

1. Pull out the Battery Holder while pressing the Stopper ①

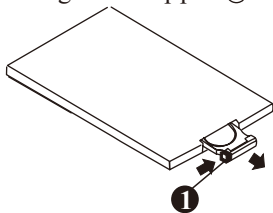

2. Put the button-type battery(+) mark upward into the Battery Holder.

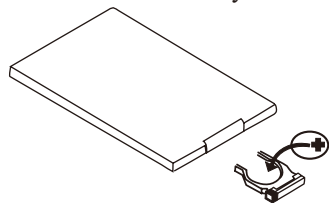

Insert the Battery Holder into the Remote Control.

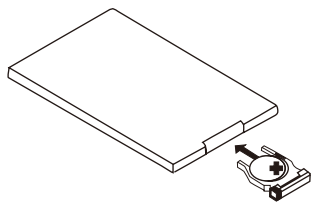

★ Note: Some models are not equipped with remote control, you should ignore the contents about remote control.

Main key

★ 1. Power Button

— Press **1**(Power) button to turn On/Off the power.

★ 2. Band

During radio mode, press **2** (BAND)to switch receiving

Band: FM1.2.3--AM

★ 3. Mode

— Press **3** (MODE) button to
FM&AM--DVD--AUX(Optional)

★ 4. MUTE

4 MUTE button to turn On/Off the mute;

5. Volume Increasing/Decreasing



Press(VOL+ or VOL-)button to increase or decrease the volume level respectively 0--40;

BASS +/-10, trber +/-10, balance +/-10, fader +/-10, loud on/off, EQ flat/class/ pop/rock/disp off/ and disc/usb/sd number 0-500 track;

Basic Operation

Turning ST/AUDIO

5. Press **5** (L/R) button to Increase the **ST** for FM stereo/Mono Disc L/R

AUX IN

6. **6** Aux In for audio input L and R
7. **7** Loud On/Off
8. **8** Disc play/pauss

Mode Selector

9. Press **9** (MODE)button to select radio mode or DISC/USB/SD play back mode and AUX in .

Senor

10. Receptor for the card remote commander.(for remote control version only)

- 11 **11** Band Selector
radio to fm/am,dvd to pal/ntsc/auto sys
- 12 **12** SEEK UP
radio tuning disc Tracks up;
- 13 **13** MUTE On/off

USB IN

- 14 . **14** USB input can auto play;
- 15 **15** SEEK DOWN
radio tuning disc Tracks down;

- 16 **16** Number Buttons
M1~M6 for radio,
Disc/usb/sd,M1=play/pause,M2=stop,
M3=repeat,M4=enter,M5=fast rewind
M6=fast forward

EJECT BUTTON

17. Press (EJECT)button **17** (Top Panle) to Eject the disc, OPEN will appear on display The key (EJECT)button only the DISC mode.

Note:power off are disability

18. **18** DISC Slot
19. **19** LCD Display
20. **20** Open(Release) Button

SD CARD

21. **21** Sd card input can auto play;

BEARING

- 22 APS **4** for disc/usb/sd only is bearin,

bearin on
5=left
6=right
seek up=down
seek down=up

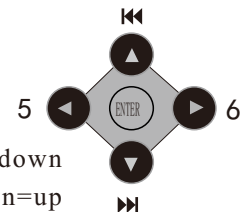

5 seconds auto exit bearin off.

Radio Operation

★ *Note: This window is used for the unit with remote control function. Without this function, you should ignore the operation contents about remote control function.*

Band Selector

1. Press **[BAND]** button repeatedly to select bands in the following order:

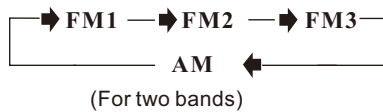

Radio seek UP/DN

2. press **[12/15]** (UP/[DN]) button to select radio seek UP/DN. series 1 secs to manual, stop 5 secs to auto;

Tuning /FastRewind/Forward

— Tuning radio mode, continuously press **(-||| or |||+)** button to Automatically search a station downward or upward respectively until it finds a station. If press and more than 3 seconds, the radio will hold **(-||| or |||+)** button for manual search a station downward or upward respectively;

Number Buttons

1~6 Number buttons for radio only
 3.(1~6) Number buttons can help you store your favorite station by pressing any one of the number buttons. You can follow the steps as below:
 Press and Hold Any **number button** until <ch> appears in the LCD display when receiving a station. And Now the is Station already stored in the corresponding number button.

(See the picture) You can store up to 18 FM stations, up to 6 AM stations.

Note: Working at 3 band fm for 1 band am. Represents

4. AS/PS(auto seek search tuning)

By pressing shortly, the radio searches for each preset station When field strength level is holding at than the threshold level of stop level The radio is holding at that preset number for 5sec With releasing mute and then searches again
 By pressing longer than 1sec, and then 6strongest stations are preset to the corresponding preset number. When as operation is finished, the radio executes the preset scan.

Location of the Remote Control

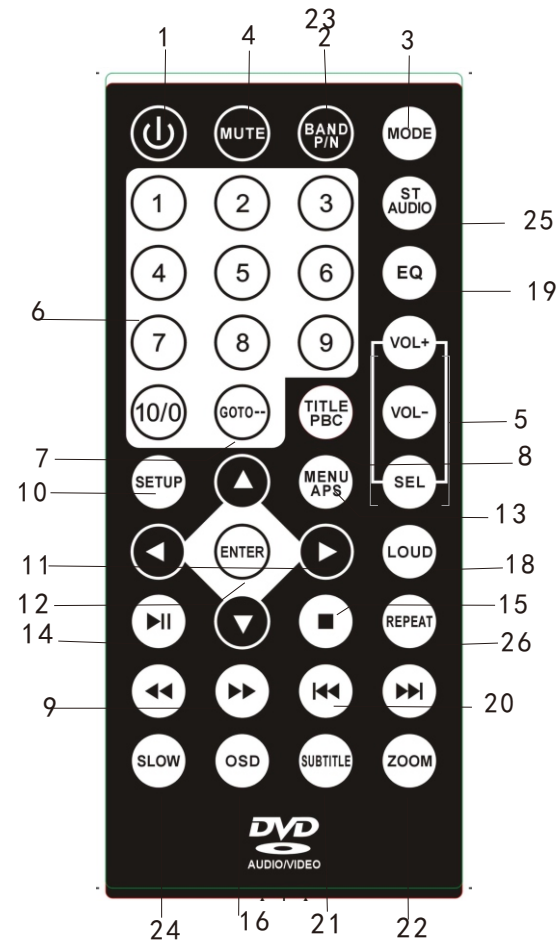

- 1** Power ON/OFF
- 2** Band /Pal/Ntsc/Auto sys
- 3** Mode
- 4** MUTE
- 5** Volume up/down
- 6** Number Button
- 7** OSD/goto
- 8** TITLE
- 9** F.F/F.REW
- 10** Setup
- 11** Selecting direction
- 12** Enter
- 13** Menu/APS
- 14** Pause/Play
- 15** Stop
- 16** OSD On/Off
- 17** LOUD
- 18** EQ
- 19** EQ
- 20** SEEK /Track up/down
- 21** Subtitle-setting
- 22** Zoom
- 23** P/N
- 24** Slow
- 25** AUDIO/ST
- 26** Repeat
- 27**
- 28** Angle

DVD、VCD、MP3、CD Operation

3. While listening to (or watching) DVD、VCD、CD、Mp3, just insert a Cds (with labeled side up) into the CD SLOT 18, the mechanism will automatically switch on. If a Cds is loaded, press 9 (MOD) button To Disc start the playing.

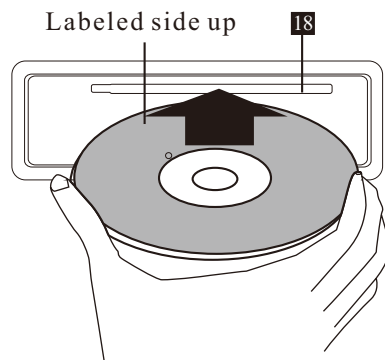

While listening to (or watching) MP3,CD-RW, just insert a Cds into the CD SLOT 18, the mechanism will automatically switch on. And the menu on the disc will display to select playing pictures or music.

A. Main menu operation:

Press 11 (↑, ↓, ←, →) key on remote controller to choose your desired contents and it will display on TV screen, then press ENTER key or press 2 to confirm. If you want change the contents you selected press (return) key to re-select.

B: Secondary menu operation:

If “ ” mark shows on screen after you selection, it means contain next secondary menu, press (ENTER) key in succession to select desired contents. (Picture 3)

DISC/USB/SD

DVD.VCD.MP4.MP3.CD Operation

SD MODE

1. SD card have music into SD connect can to play,

USB MODE

2. USB have music into USB connect can to play,
